

Wafer Flanged Ball Valve

DIN PN 16 / PN 40

Size DN 15 – DN 200 Stainless Steel



Fig. 721000 / 720000

FULL BORE

Flanged Ends



Comercial de Válvulas y Accesorios, S.A.
Polígono Industrial Polizur, Calle Bosc Tancat, 6 Nave 2 y 3
08290 Cerdanyola del valles (Barcelona) – Spain Tel. 93 586 36 00 Fax 93 586 36 04
e-mail: info@cva.es
URL: www.jlx-valve.com

Remark: The dimensions of this catalogue are for reference only and it can change without previous notice.

Wafer Flanged Ball Valve

DIN PN 16 / PN 40

Parts and materials

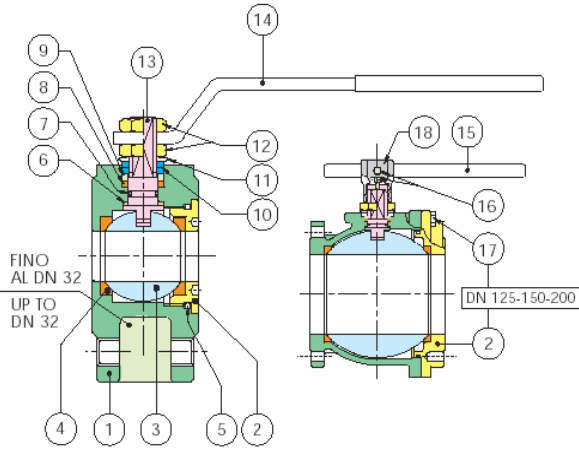

Item	Description	Material Fig. 720000	Material Fig. 721000
1	Body *	A351 - CF8 / A182-F304	A351 - CF8M / A182-F316
2	End connection	A351 - CF8 / A182-F304	A351 - CF8M / A182-F316
3	Ball	A351 - CF8 / A182-F304	A351 - CF8M / A182-F316
4	Ball seat	PTFE	PTFE
5	O'Ring	FKM (VITON®)	FKM (VITON®)
6	Thrust Washer	PTFE	PTFE
7	Ring	FKM (VITON®)	FKM (VITON®)
8	Stem seat	PTFE	PTFE
9	Packing gland	CARBON STEEL	CARBON STEEL
10	End stop	INOX AISI 430 (DN 15- DN 50) CARBON STEEL (DN65- DN200)	INOX AISI 430 (DN 15- DN 50) CARBON STEEL (DN65- DN200)
11	Spring Washer	CARBON STEEL	CARBON STEEL
12	Nut	CARBON STEEL	CARBON STEEL
13	Stem	A 182 - F304	A 182 - F316
14	Handle	CARBON STEEL	CARBON STEEL
15	Handle DN 150-200	CARBON STEEL	CARBON STEEL
16	Screw	CARBON STEEL	CARBON STEEL
17	Screw	CARBON STEEL (DN 125- DN 150) (DN 200)	CARBON STEEL (DN 125- DN 150) (DN 200)
18	Body handle DN 150-200	EN-GJL 250	EN-GJL 250

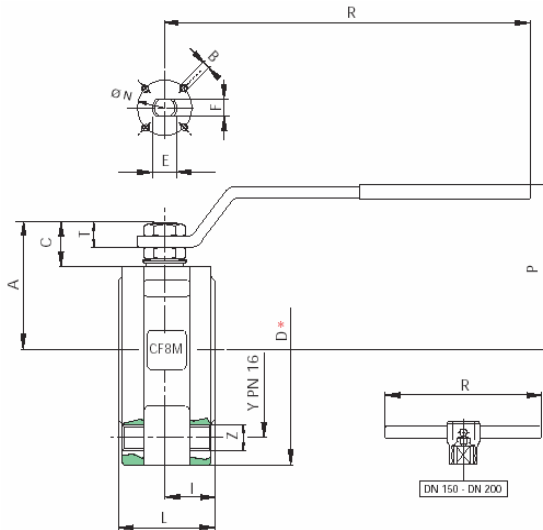

SIZE	D	Y	Z	I	L	R	P	A	C	T	E	F	N	B	KV	PN	Kg
1/2" (DN 15)	90	65	4xM12	19	35	131,5	64,5	47	15,5	9	10	7	32	4xM5	16,3	16	1,3
3/4" (DN 20)	100	75	4xM12	20	40	131,5	69	51,5	15,5	9	10	7	32	4xM5	29,5	16	1,9
1" (DN 25)	110	85	4xM12	24	46	174,5	80,5	61	19,5	11,5	12	8	42	4xM5	43	16	2,7
1 1/4" (DN 32)	130	100	4xM16	28	54	174,5	84,5	64,5	16,5	11,5	12	8	42	4xM5	89	16	4,2
1 1/2" (DN 40)	150	110	4xM16	31,75	63,5	250,5	102,5	78	24,5	13	16	10	50	4xM6	230	16	4,2
2" (DN 50)	165	125	4xM16	41	82	250,5	111	87	25	13,5	16	10	50	4xM6	265	16	6,1
2 1/2" (DN65)	185	145	4xM16	51,5	103	321,5	128	104,5	28	18	20	14	70	4xM8	540	16	10
3" (DN80)	200	160	8xM16	61	122	321,5	138,5	115	28,5	18	20	14	70	4xM8	873	16	13,5
4" (DN100)	220	180	8xM16	76	152	381,5	156,5	137	34,5	22	24	18	102	4xM10	1390	16	20,9
5" (DN125)	250	210	8xM16	98	196	381,5	178,5	159	34	22	24	18	102	4xM10	1707	16	37,5
6" (DN150)	285	240	8xM20	116	232	700	237	201,5	51,5	30	42	30	125	4xM12	2024	16	61,5
8" (DN200)	340*	295	12xM20	158,5	317	700	280	245	51,5	30	42	30	125	4xM12	2720	16	102

(*)Dimensions in mm

Comercial de Válvulas y Accesorios, S.A.

Polígono Industrial Polizur, Calle Bosc Tancat, 6 Nave 2 y 3

08290 Cerdanyola del valles (Barcelona) – Spain Tel. 93 586 36 00 Fax 93 586 36 04

e-mail: info@cva.es

URL: www.jlx-valve.com

Remark: The dimensions of this catalogue are for reference only and it can change without previous notice.



Wafer Flanged Ball Valve

DIN PN 16 / PN 40

Characteristics and Dimensions

GENERAL CHARACTERISTICS	Serie 72
DESIGN STANDARDS	
Rating	PN 16 - 40
Nominal Diametre	From DN 15 to DN 200
Maneuver	90° rotation of the lever
Testing	100% tested
Operator	UNI 7070 handle with blue PVC cover

APPLICATION
Assembly in flanged rigid pipe system
Other specifications in the "Technical Specifications" catalogue
Nominal pressure (PN) in bar
For temperature > 80°C see diagram in the Technical Specifications catalogue
KV: flow coefficient in m ³ /h at differential pressure of 100 kPa
Vacuum: Maximum 10 ⁻³ torr.
Temperature range: -20°C +160°C
Direction of flow : both directions
We recommend the valve use in fully open or closed, not in mid position, and to manoeuvre the valve at least twice a year.

OPTIONS AVAILABLE	
720002	AISI 316 CF8M. Integral seat PTFE DN100 from barstock
720003	AISI 316 CF8M. Flange PN 10 DN 80 - DN 200
720004	AISI 316 CF8M. Jackted end connection 1/2" gas from DN 15 to DN 80, 1" from DN 100 to DN 200
720005	AISI 316 CF8M. Seats glass filled PTFE
720022	AISI 316 CF8M. Jackted flange DN 15 from DN 15 to DN 80. Flange DN 25 from DN 100 to DN 200
720055	AISI 316 CF8M. Seats-seals PTFE + 25% coal
720025	AISI 316 CF8M. Stainless steel components
720184	AISI 316 CF8M Fire Safe
720186	AISI 304 CF8 Fire Safe



Comercial de Válvulas y Accesorios, S.A.
Polígono Industrial Polizur, Calle Bosc Tancat, 6 Nave 2 y 3
08290 Cerdanyola del valles (Barcelona) – Spain Tel. 93 586 36 00 Fax 93 586 36 04
e-mail: info@cva.es
URL: www.jlx-valve.com

Remark: The dimensions of this catalogue are for reference only and it can change without previous notice.

Wafer Flanged Ball Valve with actuators

Double Acting Actuator

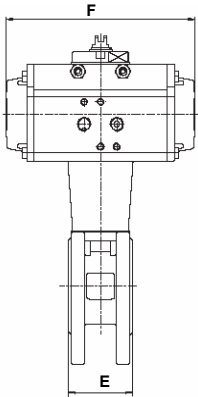

SIZE	A	B	C	D	E	F	ACT
1/2" (DN 15)	191	236	90	76	35	145	ADA-20
3/4" (DN 20)	196	246	100	76	40	145	ADA-20
1" (DN 25)	201	256	110	76	46	145	ADA-20
1" 1/4 (DN 32)	230	295	130	91	54	158	ADA-40
1" 1/2 (DN 40)	240	315	150	91	64	158	ADA-40
2" (DN 50)	269,5	352	165	111	82	177	ADA-80
2 1/2" (DN 65)	289,5	382	185	122	103	196	ADA-130
3" (DN 80)	297	397	200	122	122	196	ADA-130
4" (DN 100)	335	445	220	135,5	152	225	ADA-200
5" (DN 125)	350	475	250	135,5	196	225	ADA-200
6" (DN 150)	401,5	544	285	173	232	304	ADA-500
8" (DN 200)	451	621	340	191,5	317	372	ADA-850

Spring Return Actuator

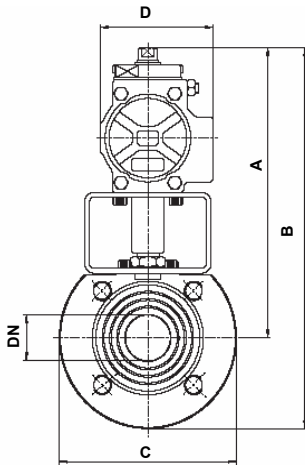

SIZE	A	B	C	D	E	F	ACT
1/2" (DN 15)	191	236	90	76	35	163	ASR-20
3/4" (DN 20)	215	265	100	91	40	195	ASR-40
1" (DN 25)	220	275	110	91	46	195	ASR-40
1" 1/4 (DN 32)	230	295	130	91	54	195	ASR-40
1" 1/2 (DN 40)	240	315	150	91	64	195	ASR-40
2" (DN 50)	279,5	362	165	122	82	258	ASR-130
2 1/2" (DN 65)	307,5	400	185	135,5	103	299	ASR-200
3" (DN 80)	315	415	200	135,5	122	299	ASR-200
4" (DN 100)	352	462	220	152,5	152	348,5	ASR-300
5" (DN 125)	367	492	250	152,5	196	348,5	ASR-300
6" (DN 150)	423,5	566	285	191,5	232	473	ASR-850
8" (DN 200)	451	621	340	191,5	317	473	ASR-850



Comercial de Válvulas y Accesorios, S.A.
 Polígono Industrial Polizur, Calle Bosc Tancat, 6 Nave 2 y 3
 08290 Cerdanyola del valles (Barcelona) – Spain Tel. 93 586 36 00 Fax 93 586 36 04
 e-mail: info@cva.es

URL: www.jlx-valve.com

Remark: The dimensions of this catalogue are for reference only and it can change without previous notice.

Wafer Flanged Ball Valve

DIN PN 16 / PN 40

Special Uses

Flanged ball valve, with jacket in stainless or carbon steel, full bore, sizes DN 15 to DN 200, threaded end connection:

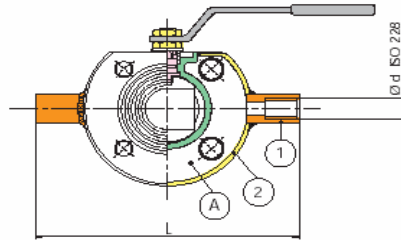

SIZE	Ød	Lmm	
		Carbon steel	Stainless Steel
DN15	1/2"	189	
DN20	1/2"	199	
DN25	1/2"	210	
DN32	1/2"	230	
DN40	1/2"	240	
DN50	1/2"	254	
DN65	1/2"	275	259
DN80	1/2"	290	274
DN100	1"	336	294
DN125	1"	366	324
DN150	1"	416	359
DN200	1"	414	

Item	Description	Material	
1	End connection	ASTM 105	A182-F316
2	Jacket	CARBON STEEL	STAINLESS STEEL

Flanged ball valve, with jacket in stainless or carbon steel, full bore, sizes DN 15 to DN 200, flanged end connection:

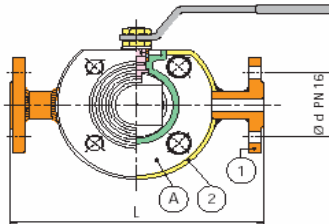

Item	Description	Material	
1	Flange	ASTM 105	A182-F316
2	Jacket	CARBON STEEL	STAINLESS STEEL

SIZE	Ød	Lmm	
		Carbon steel	Stainless Steel
DN15	DN15	189	
DN20	DN15	199	
DN25	DN15	210	
DN32	DN15	230	
DN40	DN15	240	
DN50	DN15	254	
DN65	DN15	275	259
DN80	DN15	290	274
DN100	DN25	336	294
DN125	DN25	366	324
DN150	DN25	416	359
DN200	DN25	414	



Comercial de Válvulas y Accesorios, S.A.
 Polígono Industrial Polizur, Calle Bosc Tancat, 6 Nave 2 y 3
 08290 Cerdanyola del valles (Barcelona) – Spain Tel. 93 586 36 00 Fax 93 586 36 04
 e-mail: info@cva.es

URL: www.jlx-valve.com

Remark: The dimensions of this catalogue are for reference only and it can change without previous notice.

Wafer Flanged Ball Valve

DIN PN 16 / PN 40

Special Uses

Metal core P.T.F.E. seated ball valve with relief hole:

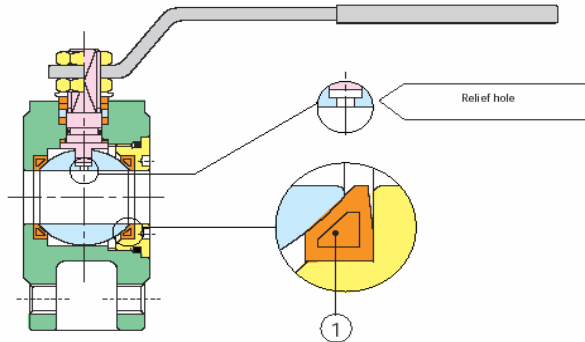

Item	Description	Material
1	Ball seats	PTFE + ANIMA METALLICA / METAL CORE

Valve with gear box operator:



Manual valve with box limit switches:



Comercial de Válvulas y Accesorios, S.A.
Polígono Industrial Polizur, Calle Bosc Tancat, 6 Nave 2 y 3
08290 Cerdanyola del valles (Barcelona) – Spain Tel. 93 586 36 00 Fax 93 586 36 04
e-mail: info@cva.es
URL: www.jlx-valve.com

Remark: The dimensions of this catalogue are for reference only and it can change without previous notice.